



Tecnodeck Fence System









- Tecnodeck Fence System is a totally modular system and provides a several customized possible solutions.
- Tecnodeck Fence System was designed and conceived according to the Eurocode specifications.
- Tecnodeck Fence System is presented in two standard versions:
 - Light Version, with aluminium structure Tube, designed according the Eurocode points 1, 3 and 9, suitable for winds up to 60 km/h.
 - Strong Version, with steel structure Tube, designed according the Eurocode full version, suitable for winds up to 120 km/h.

NOTE: The base plate version is not suitable for wind loads.
- Union components are in galvanized steel and lacquered.
 - Exterior profiles are in Tecnodeck Wood Plastic Composite.
 - Interior reinforcing profiles are in 6060 T6 aluminium or S355 steel.
- The Tecnodeck Fence System should be applied to solid, flat and stable surface, such as concrete slabs with self-leveling mass.
- The concrete must have the characteristics necessary to withstand wind pressure.
- Never fix the bases direct over the decking (if it exists).
- The fixation should be always to the concrete sub-floor.
- Exception for the version with base plate, not suitable wind load.
- When fitting the WPC Fence Profile, in the U Fence Aluminium Profile, a 3 mm gap should be considered on each side in way to allow natural thermal expansions of the material.

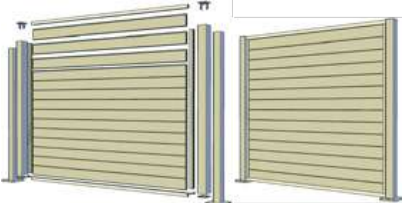

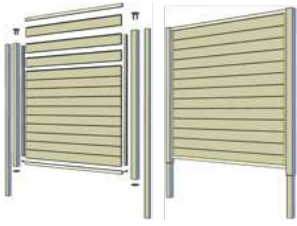

Index

Pages

Index	Pages
 <p>Tecnodeck Fence System 2x2 Light Version Fixed Base</p>	6
 <p>Tecnodeck Fence System 2x2 Light Version Fixed Base - Add Up</p>	9
 <p>Tecnodeck Fence System 2x2 Strong Version Fixed Base</p>	10
 <p>Tecnodeck Fence System 2x2 Strong Version Fixed Base - Add Up</p>	11
 <p>Tecnodeck Fence System 2x2 Light Version Fixed to the ground</p>	12
 <p>Tecnodeck Fence System 2x2 Light Version Fixed to the ground - Add Up</p>	13
	14

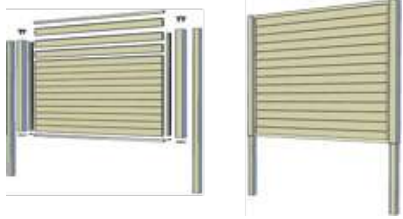
Index

Pages

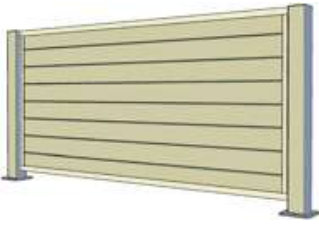
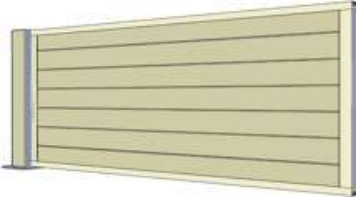
	<p>Tecnodeck Fence System 2x2 Strong Version Fixed to the ground</p>	<p>15</p>
	<p>Tecnodeck Fence System 2x2 Strong Version Fixed to the ground - Add Up</p>	<p>16</p>
	<p>Tecnodeck Fence System 2x2 Light Version Not fixed with base plate * Not suitable for wind loads</p>	<p>17</p>
	<p>Tecnodeck Fence System 2x2 Light Version Not fixed with base plate - Add Up * Not suitable for wind loads</p>	<p>18</p>
	<p>Tecnodeck Fence System 2x1,2 Light Version Fixed Base</p>	<p>19</p>
	<p>Tecnodeck Fence System 2x1,2 Light Version Fixed Base - Add Up</p>	<p>20</p>

Index

Pages

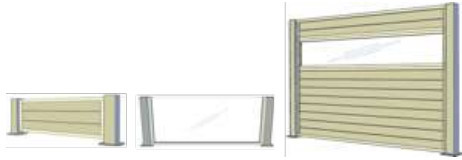

Customized Tecnodeck Fence

Tecnodeck Fence Base for
Non-Orthogonal Assemblies

21

Dimensions Fence 2x2
Dimensions Fence 2x1.2









24

Technical Features

25

* Tecnodeck Fence System is a totally modular system and provides a several customized possible solutions.



Components

Description	Drawing
Tecnodeck Profile 85 x 85 x 2000 mm	
Tecnodeck Profile 85 x 85 x 1200 mm	
Tecnodeck ALU Profile 68 x 68 x 2000 mm	
Tecnodeck ALU Profile 38 x 20 x 1200 mm	
Fence Base [+ Fixings]	
Tecnodeck U ALU Profile x 2000 mm [+ Fixings]	
Tecnodeck U ALU Profile x 1200 mm [+ Fixings]	
Tecnodeck Fence Profile x 2000 mm	

Components

Description	Drawing
Tecnodeck Fence L Profile [+ Fixings]	
Caps	
Spacer 85 x 85 x 5	
Finishing Plate Lacquered 170 x 170/2	
Finishing Plate Stainless Steel 170 x 170/2 Inox A4	
Screw Cap	
Steel Base Column x 2000 mm [+ Fixings]	
Finishing Plate Lacquered 170 x 170/2 Split Execution	

Components

Description	Drawing
Finishing Plate Stainless Steel 170 x 170/2 Inox A4 Split Execution	
Steel Column 70 x 70 x 3000 mm	
Fence Base [+ Fixings]	



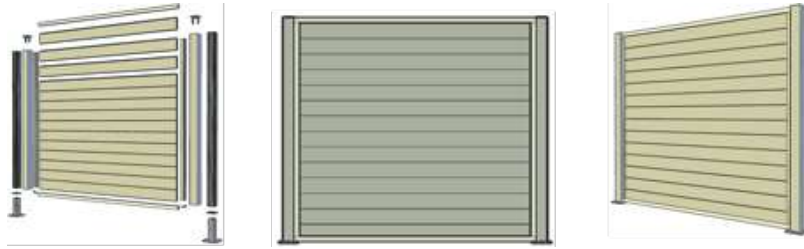



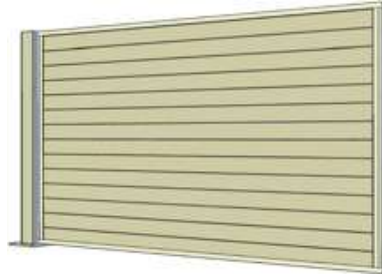

**Tecnodeck Fence System 2x2 Light Version
 Fixed Base**



Quantity	Description	Drawing
2	Tecnodeck Profile 85 x 85 x 2000 mm	
2	Tecnodeck ALU Profile 68 x 68 x 2000 mm	
2	Fence Base [+ Fixings]	
4	Tecnodeck U ALU Profile x 2000 mm [+ Fixings]	
13 (140x20) 12 (150x20)	Tecnodeck Fence Profile x 2000 mm	
2	Tecnodeck Fence L Profile [+ Fixings]	
2	Caps	
2	Spacer 85 x 85 x 5	







**Tecnodeck Fence System 2x2 Light Version
 Fixed Base - Add Up**

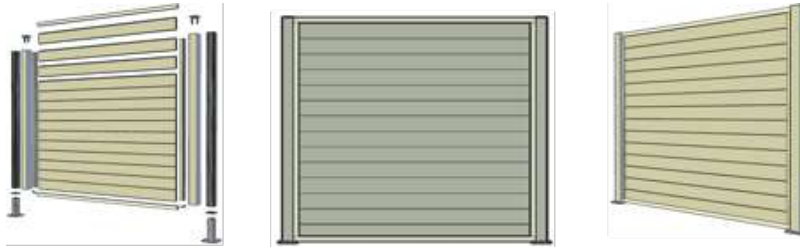

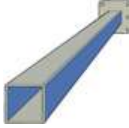
Quantity	Description	Drawing
1	Tecnodeck Profile 85 x 85 x 2000 mm	
1	Tecnodeck ALU Profile 68 x 68 x 2000 mm	
1	Fence Base [+ Fixings]	
4	Tecnodeck U ALU Profile x 2000 mm [+ Fixings]	
13 (140x20) 12 (150x20)	Tecnodeck Fence Profile x 2000 mm	
2	Tecnodeck Fence L Profile [+ Fixings]	
1	Caps	
1	Spacer 85 x 85 x 5	







**Tecnodeck Fence System 2x2 Strong Version
 Fixed Base**

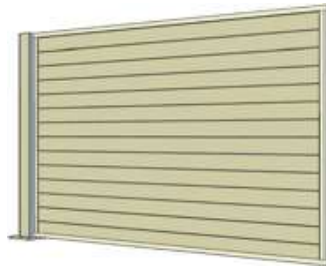

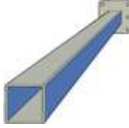
Quantity	Description	Drawing
2	Tecnodeck Profile 85 x 85 x 2000 mm	
2	Steel Base Column x 2000 mm [+ Fixings]	
4	Tecnodeck U ALU Profile x 2000 mm [+ Fixings]	
13 (140x20) 12 (150x20)	Tecnodeck Fence Profile x 2000 mm	
2	Tecnodeck Fence L Profile [+ Fixings]	
2	Caps	
2	Spacer 85 x 85 x 5	







**Tecnodeck Fence System 2x2 Strong Version
 Fixed Base - Add Up**



Quantity	Description	Drawing
1	Tecnodeck Profile 85 x 85 x 2000 mm	
1	Steel Base Column x 2000 mm [+ Fixings]	
4	Tecnodeck U ALU Profile x 2000 mm [+ Fixings]	
13 (140x20) 12 (150x20)	Tecnodeck Fence Profile x 2000 mm	
2	Tecnodeck Fence L Profile [+ Fixings]	
1	Caps	
1	Spacer 85 x 85 x 5	







**Tecnodeck Fence System 2x2 Light Version
 Fixed to the Ground**

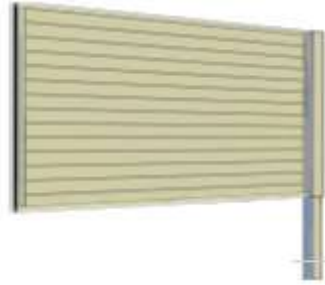

Quantity	Description	Drawing
2	Tecnodeck Profile 85 x 85 x 2000 mm	
2	Tecnodeck ALU Profile 68 x 68 x 2500 mm	
4	Tecnodeck U ALU Profile x 2000 mm [+ Fixings]	
13 (140x20) 12 (150x20)	Tecnodeck Fence Profile x 2000 mm	
2	Tecnodeck Fence L Profile [+ Fixings]	
2	Caps	
2	Spacer 85 x 85 x 5	







**Tecnodeck Fence System 2x2 Light Version
 Fixed to the Ground - Add Up**



Quantity	Description	Drawing
1	Tecnodeck Profile 85 x 85 x 2000 mm	
1	Tecnodeck ALU Profile 68 x 68 x 2500 mm	
4	Tecnodeck U ALU Profile x 2000 mm [+ Fixings]	
13 (140x20) 12 (150x20)	Tecnodeck Fence Profile x 2000 mm	
2	Tecnodeck Fence L Profile [+ Fixings]	
1	Caps	
1	Spacer 85 x 85 x 5	







**Tecnodeck Fence System 2x2 Strong Version
 Fixed to the ground**

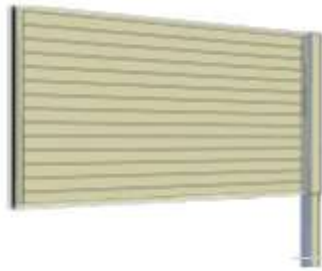

Quantity	Description	Drawing
2	Tecnodeck Profile 85 x 85 x 2000 mm	
2	Steel Column 70 x 70 x 3000 mm	
4	Tecnodeck U ALU Profile x 2000 mm [+ Fixings]	
13 (140x20) 12 (150x20)	Tecnodeck Fence Profile x 2000 mm	
2	Tecnodeck Fence L Profile [+ Fixings]	
2	Caps	
2	Spacer 85 x 85 x 5	







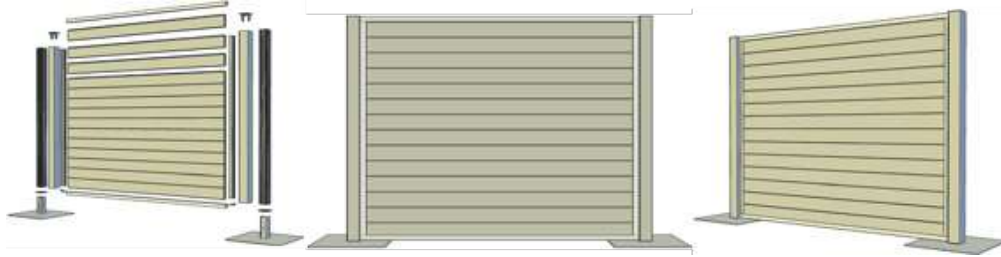

**Tecnodeck Fence System 2x2 Strong Version
 Fixed to the ground - Add Up**



Quantity	Description	Drawing
1	Tecnodeck Profile 85 x 85 x 2000 mm	
1	Steel Column 70 x 70 x 3000 mm	
4	Tecnodeck U ALU Profile x 2000 mm [+ Fixings]	
13 (140x20) 12 (150x20)	Tecnodeck Fence Profile x 2000 mm	
2	Tecnodeck Fence L Profile [+ Fixings]	
1	Caps	
1	Spacer 85 x 85 x 5	









**Tecnodeck Fence System 2x2 Light Version
 Not Fixed with Base Plate**



Quantity	Description	Drawing
2	Tecnodeck Profile 85 x 85 x 2000 mm	
2	Tecnodeck ALU Profile 68 x 68 x 2000 mm	
2	Fence Base [+ Fixings]	
8	Tecnodeck U ALU Profile x 2000 mm [+ Fixings]	
13 (140x20) 12 (150x20)	Tecnodeck Fence Profile x 2000 mm	
2	Tecnodeck Fence L Profile [+ Fixings]	
2	Caps	
2	Spacer 85 x 85 x 5	







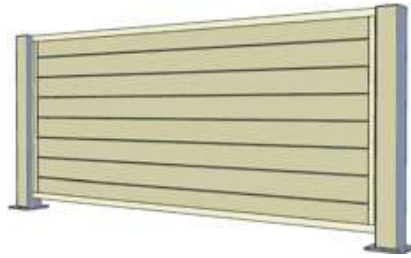

**Tecnodeck Fence System 2x2 Light Version
 Not Fixed with Base Plate - Add Up**



Quantity	Description	Drawing
1	Tecnodeck Profile 85 x 85 x 2000 mm	
1	Tecnodeck ALU Profile 68 x 68 x 2000 mm	
1	Fence Base [+ Fixings]	
8	Tecnodeck U ALU Profile x 2000 mm [+ Fixings]	
13 (140x20) 12 (150x20)	Tecnodeck Fence Profile x 2000 mm	
2	Tecnodeck Fence L Profile [+ Fixings]	
1	Caps	
1	Spacer 85 x 85 x 5	

**Tecnodeck Fence System 2x1,2 Light Version
 Fixed Base**



Quantity	Description	Drawing
2	Tecnodeck Profile 85 x 85 x 1200 mm	
2	Tecnodeck ALU Profile 68 x 68 x 1200 mm	
2	Fence Base [+ Fixings]	
2	Tecnodeck U ALU Profile x 2000 mm [+ Fixings]	
2	Tecnodeck U ALU Profile x 1200 mm [+ Fixings]	
8 (140x20) 7 (150x20)	Tecnodeck Fence Profile x 2000 mm	
2	Tecnodeck Fence L Profile [+ Fixings]	
2	Caps	
2	Spacer 85 x 85 x 5	

**Tecnodeck Fence System 2x1,2 Light Version
 Fixed Base - Add Up**

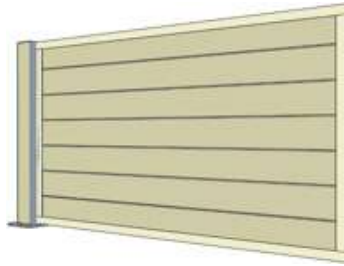

Quantity	Description	Drawing
1	Tecnodeck Profile 85 x 85 x 1200 mm	
1	Tecnodeck ALU Profile 68 x 68 x 1200 mm	
1	Fence Base [+ Fixings]	
2	Tecnodeck U ALU Profile x 2000 mm [+ Fixings]	
2	Tecnodeck U ALU Profile x 1200 mm [+ Fixings]	
8 (140x20) 7 (150x20)	Tecnodeck Fence Profile x 2000 mm	
2	Tecnodeck Fence L Profile [+ Fixings]	
1	Caps	
1	Spacer 85 x 85 x 5	

Tecnodeck Fence Base for Non-Orthogonal Assemblies

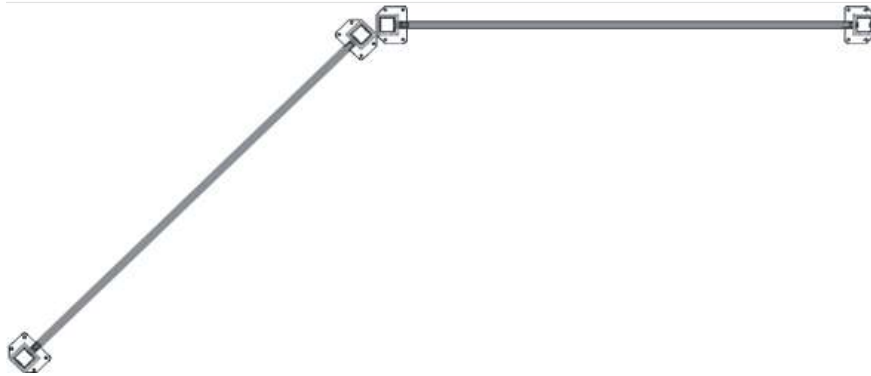
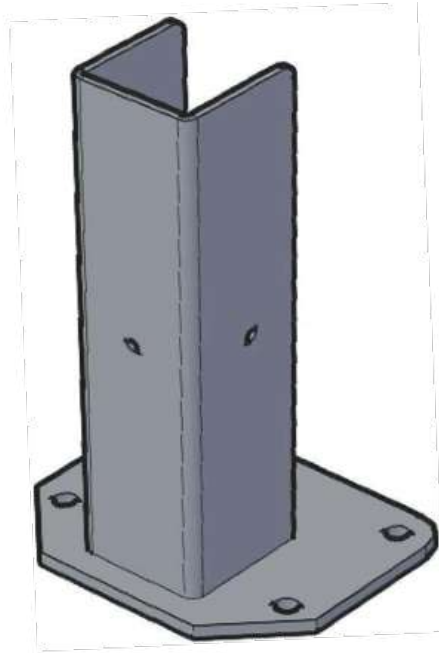

Tecnodeck Fence System Light Version, with aluminium structure tube, designed according the Eurocode points 1, 3 and 9, suitable for winds up to 60 km/h.

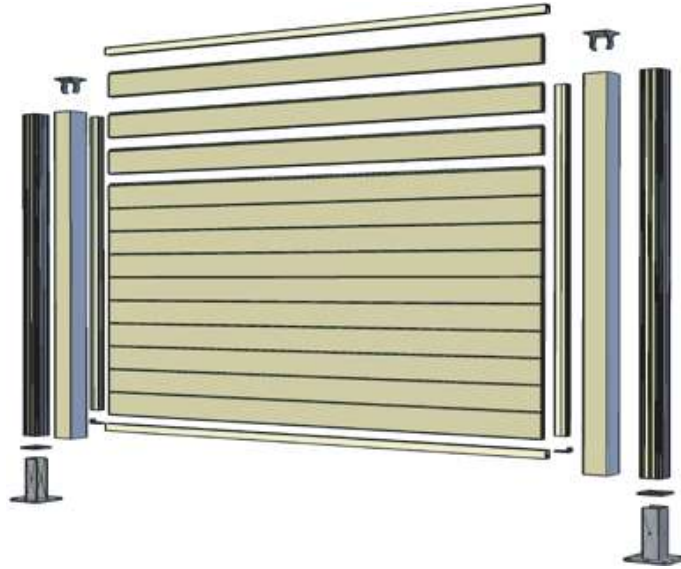

Tecnodeck Fence System Strong Version, with steel structure tube, designed according the Eurocode full version, suitable for winds up to 120 km/h.

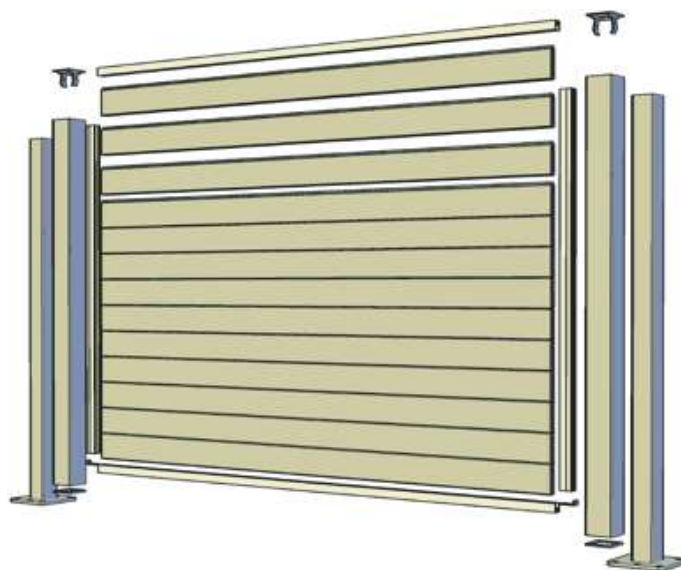

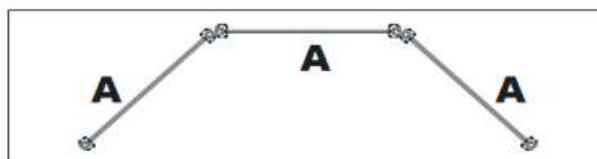
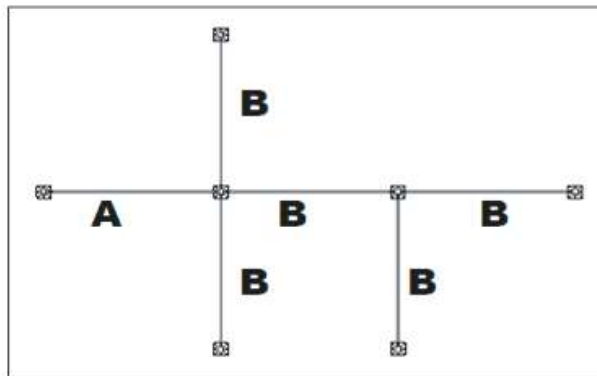
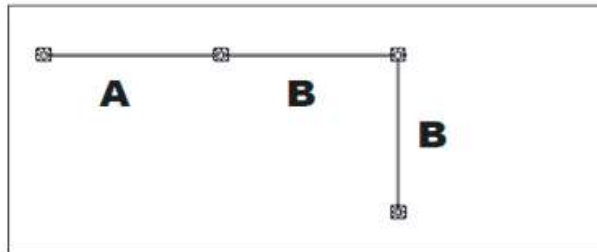
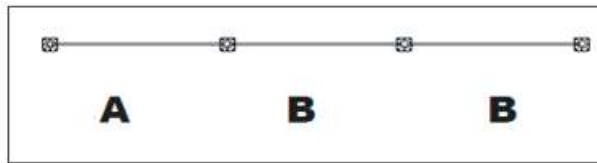
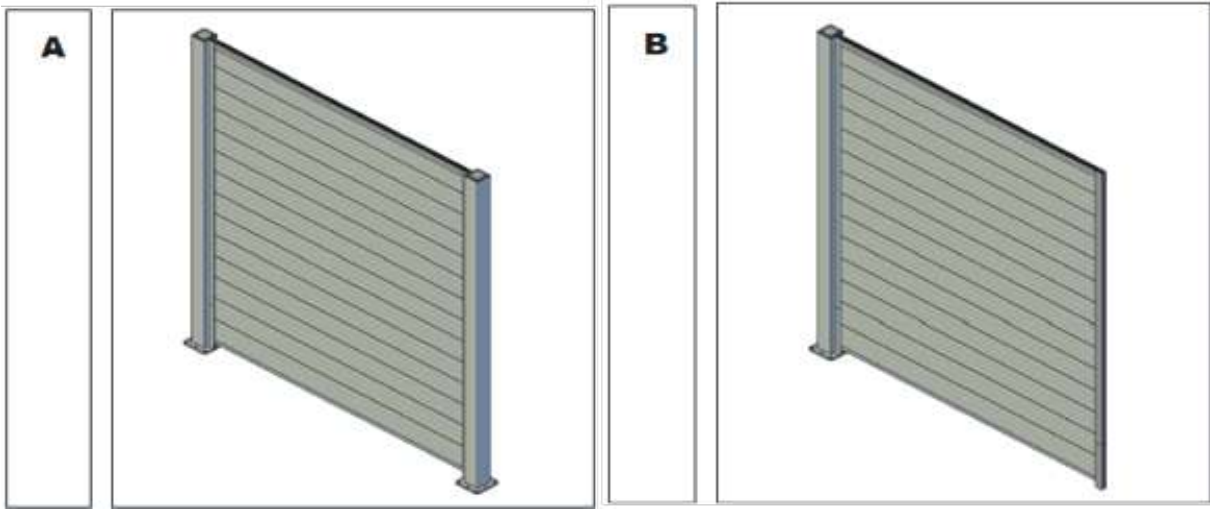

Dimension Fence 2x2

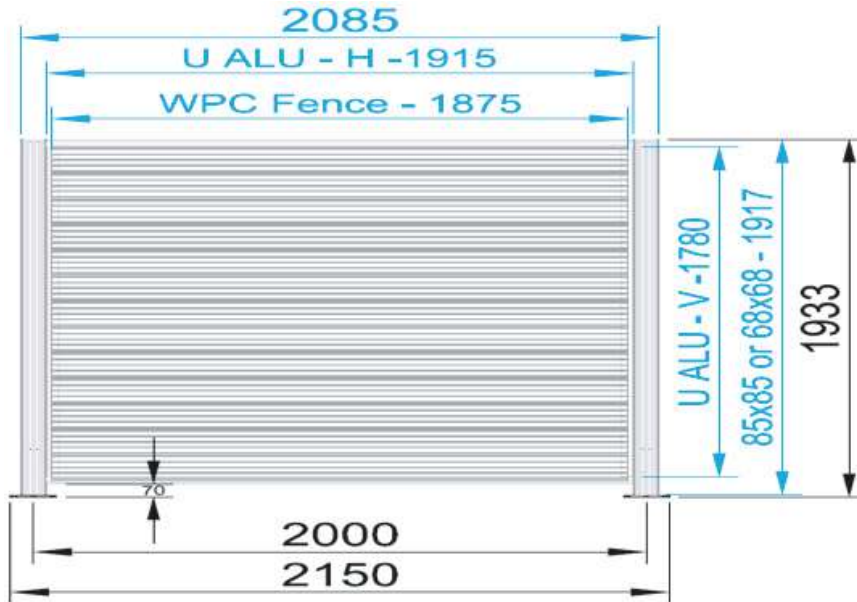

Dimension Fence 2x1.2

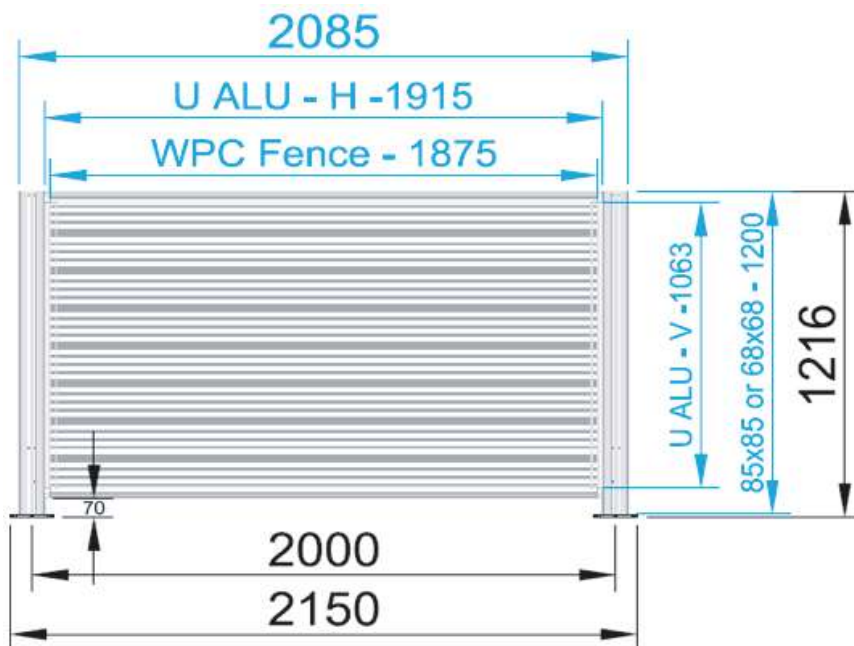

Technical Features

Tecnodeck Profile 85x85 and Fence Profile

Density g/cm ³	1,3
Water Absorption (Weight)	0,3
% (Volume)	0,17
Tensile Strength Mpa	22,5
Breaking Modulus Mpa	22
Flexural Strenght Mpa	22,5
Modulus of Elasticity Mpa	2400
Compression Resistance Mpa	26,4
Thermal Expansion Coefficient (mm/mm) / °C	4,9x10 ⁻⁵

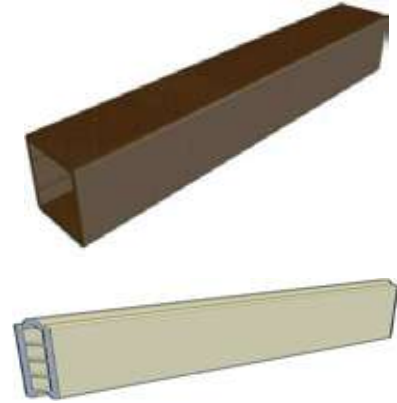

Tecnodeck ALU Profile 68x68, 38x20, 20x10

Alloy Designation	6060 T6
Tensile Strength Mpa	190
Yield Strength Mpa	150
Hardness Vickers (aprox.)	60
Modulus of Elasticity Gpa	70
Modulus of Rigidity Gpa	27
Density g/cm ³	2,7



Tecnodeck ST Profile 70x70

Alloy Designation	S235
Tensile Strength Mpa	190
Yield Strength Mpa	235
Hardness Vickers (aprox.)	360
Modulus of Elasticity Gpa	210
Density g/cm ³	7,85

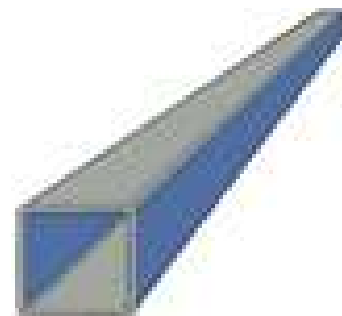

Note: These features are only for information purposes, and the manufacturer may change them without previous notice.